

# INIGO

PROPERTY NAME

Llanwarne

LOCATION

Hereford

Approximate Floor Area = 129.6 sq m / 1395 sq ft  
Including Limited Use Area (0.2 sq m / 2 sq ft)

*Illustration for identification purposes only,  
measurements are approximate, not to scale*

*Viewing Arrangements*

Telephone: +44 (0)20 3687 3071

Email: [viewings@inigo.com](mailto:viewings@inigo.com)

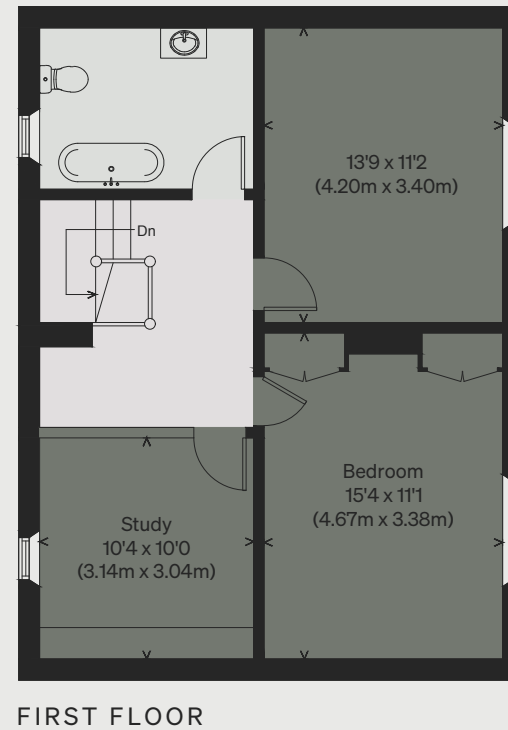
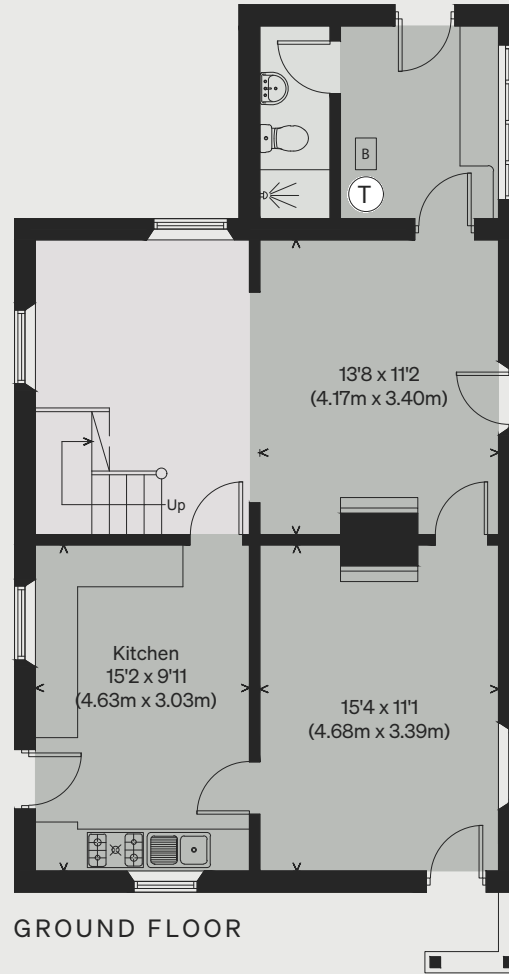
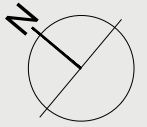

= Reduced head height below 1.5m

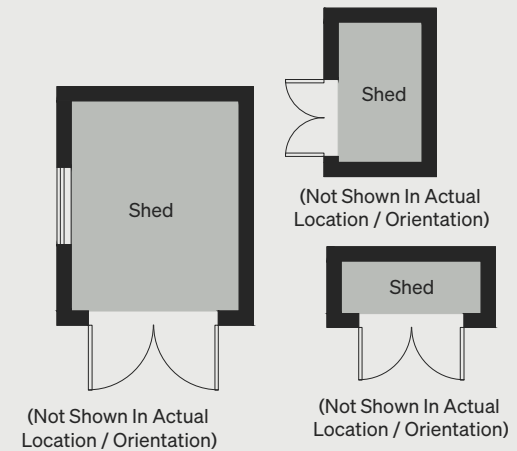

# INIGO

PROPERTY NAME  
Llanwarne

LOCATION  
Hereford

Approximate Floor Area = 60.0 sq m / 646 sq ft  
(Including Mezzanine)  
Including Limited Use Area (0.5 sq m / 5 sq ft)

*Illustration for identification purposes only,  
measurements are approximate, not to scale*

*Viewing Arrangements*

Telephone: +44 (0)20 3687 3071

Email: [viewings@inigo.com](mailto:viewings@inigo.com)

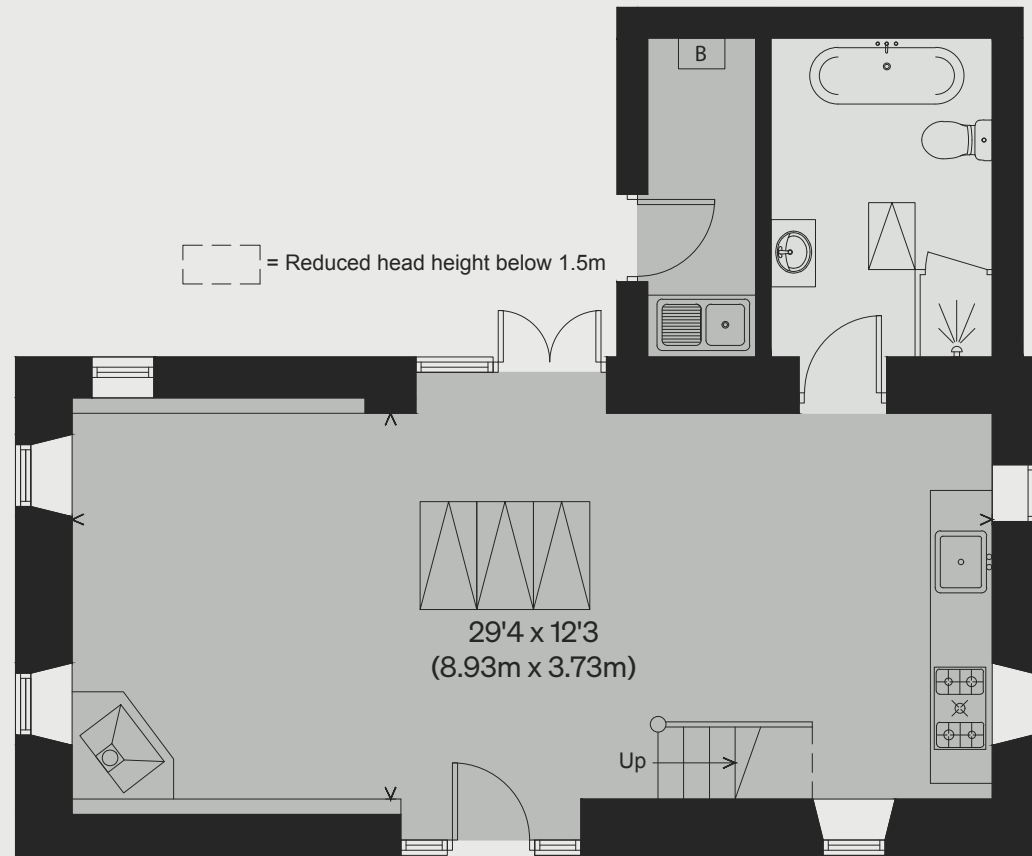
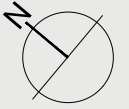

GROUND FLOOR

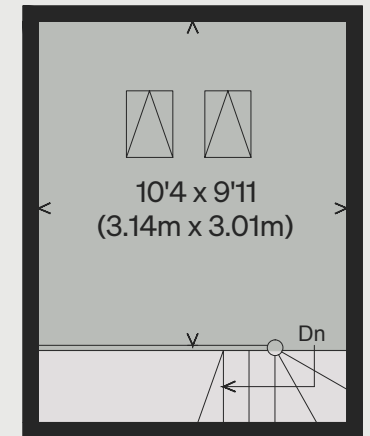

MEZZANINE LEVEL